

## Liquid Line F3 | System 60mm Recessed

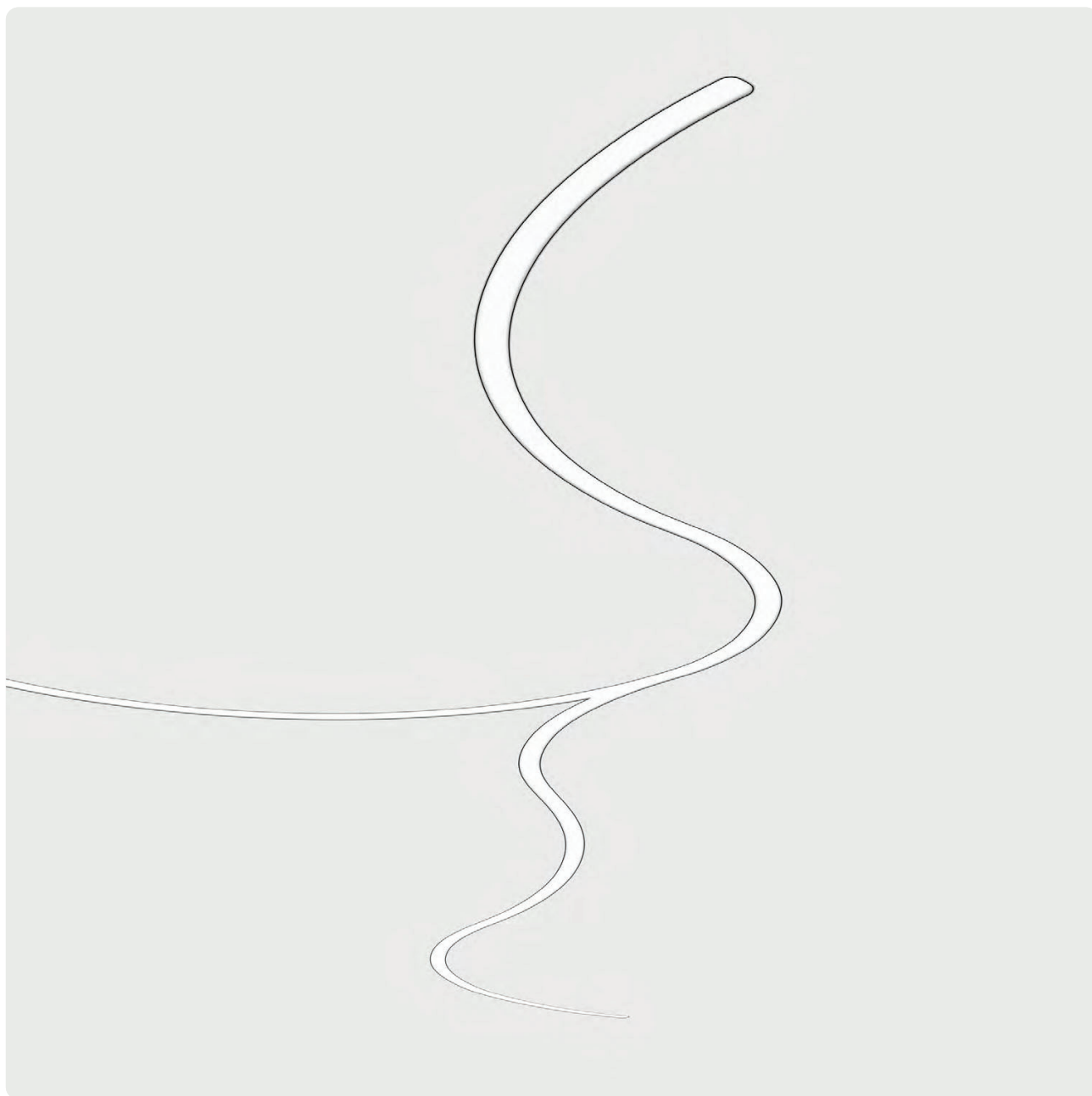

**DE** LED-System-Einbauleuchte für gesägte Deckenöffnungen. Rein direktstrahlend. Hochflexibles System bestehend aus linearen Elementen, gebogenen Elementen sowie Y- und X-Verbindungselementen. Jedes Modul ist dabei als unabhängige Einzeleuchte mit integriertem Konverter konzipiert und kann mit den anderen Modulen durch ein durchdachtes Konnektor-System zu beliebigen Lichtstrukturen verbunden werden. Millimetergenaue Längenfertigung sowie Sonderradien durch intelligentes softwarebasiertes Produktionssystem in Stückzahl 1 möglich. Auf Grundlage skizzierter Kundenvorgabe erstellt Lightnet technische Zeichnung der gewünschten Struktur zur Prüfung und Freigabe. Maximale Flexibilität ermöglicht nahezu 100%ige Umsetzung von kundenseitiger Entwurfsskizze in Produktions-

zeichnung. Leuchtenkörper mit feinen Radien aus Aluminiumprofil mit 60mm Optikbreite, gefertigt aus einem Guss ohne sichtbare Nahtstellen an den Stirnseiten. Oberfläche weiß, silber, graphit, schwarz, champagner oder kupferfarben lackiert. Weitere Oberflächenoptionen siehe Lightnet-Surface-Collection oder RAL nach Wahl. Microprismenoptik mit optimierter Blendungsbegrenzung speziell für Office-Anwendungen. Satinierter Opaldifusor für Allgemeinbeleuchtung. Konverter wahlweise einfach schaltbar oder stufenlos dimmbar (DALI, Touch-Dim, Casambi). Farbtemperatur 2200K, 2700K, 3000K, 3500K, 4000K oder 6500K. Binning initial  $\leq$  MacAdam 3. Farbwiedergabe CRI $>$ 80, CRI $>$ 90 oder Full Spectrum.

**Linear Modules**

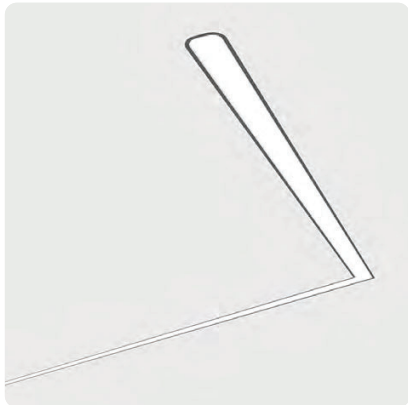

**Linear Line**

L[mm]	600	888	1178	1472	2340
-------	-----	-----	------	------	------

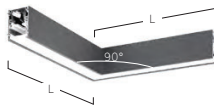

**Sharp Corner**

L[mm]	500
-------	-----

**Curve Modules**

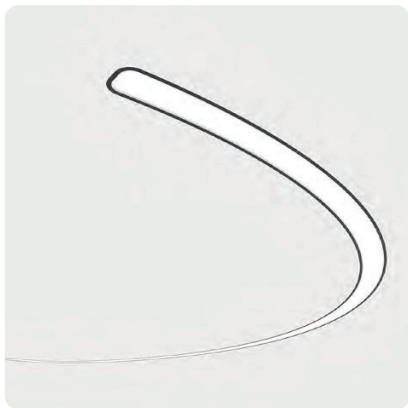

**CH 1/2 Curve**

R[mm]	500	750	1000
L[mm]	1570	2355	3140



**CQ 1/4 Curve**

R[mm]	500	750	1000	1250	1500	1750	2000
L[mm]	785	1178	1571	1964	2356	2749	3142



**CE 1/8 Curve**

R[mm]	1000	1500	2000	2500	3000	3500	4000
L[mm]	785	1178	1571	1964	2356	2749	3142

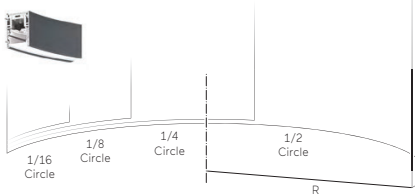

**CS 1/16 Curve**

R[mm]	2000	3000	3500
L[mm]	785	1178	1374

**EN** LED recessed light system for installation in ceiling cut-outs openings. Direct only light distribution. Highly flexible system consisting of linear elements, curved elements and Y- and X-connectors. Each module is designed as a stand-alone luminaire with an integrated driver and can be connected to the other modules using a sophisticated connector system to create any desired lighting structure. Millimeter-precise production as well as special curves (Opal only) possible. Based on customer specifications, Lightnet creates technical drawings of the desired structure for review and approval. Luminaire body

with smooth bends made of aluminium profile with 60mm optics width, crafted in one piece with no visible seams. Surface white, silver, graphite, black, champagne or copper coated. Further surface options see Lightnet-Surface-Collection or RAL of your choice. Microprismatic screen with optimized glare reduction especially for workplaces. Satin opal diffuser for general lighting. Driver optionally switchable or dimmable (DALI, Touch-Dim, Casambi). Colour temperature 2200K, 2700K, 3000K, 3500K, 4000K or 6500K. Binning ≤ MacAdam 3. Colour rendering CRI>80, CRI>90 or Full Spectrum.

**X-Junction Modules**

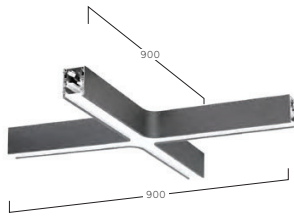

**X1-Junction Module**

L[mm] 1920

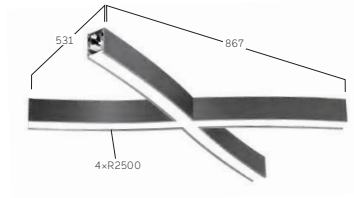

**X2-Junction Module**

L[mm] 1800

**Y-Junction Modules**

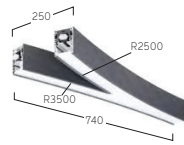
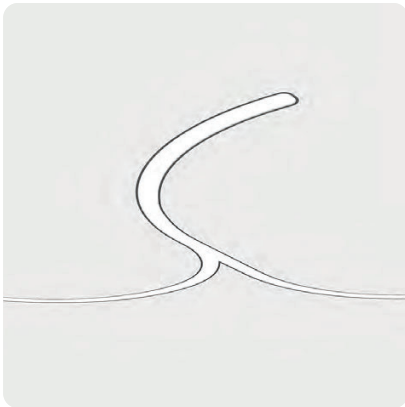

**Y1-Junction**

L[mm] 1450

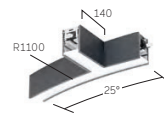

**Y4-Junction**

L[mm] 620

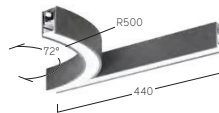

**Y2-Junction**

L[mm] 1069

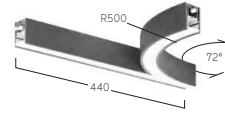

**Y5-Junction**

L[mm] 1069

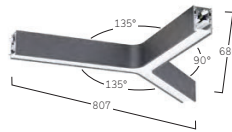

**Y3-Junction**

L[mm] 1875

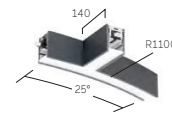

**Y6-Junction**

L[mm] 620

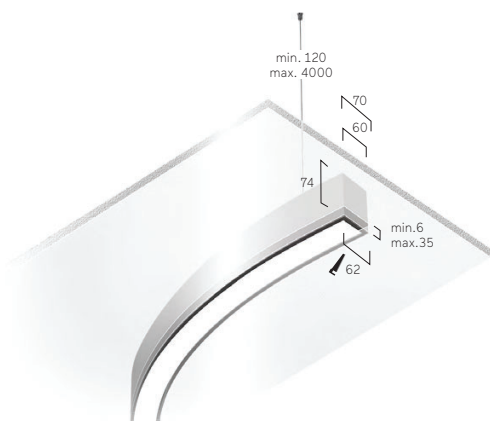



IP20 ~220-240V 50-60 Hz IK 02 RG0  $\leq 3$  MacAdam LOW POWER L90B10 50,000h MEDIUM POWER L85B10 50,000h HIGH POWER L80B10 50,000h

**Microprismatic | Direct**

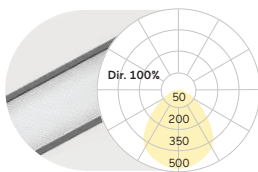

**Lumen/Watt Low Power** 1200lm/14,6W per m  
**Lumen/Watt Medium Power** 1760lm/22,5W per m  
**Lumen/Watt High Power** 2290lm/30,3W per m

**Opal Diffuser | Direct**

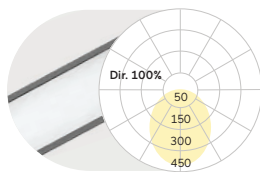

**Lumen/Watt Low Power** 1300lm/14,6W per m  
**Lumen/Watt Medium Power** 1910lm/22,5W per m  
**Lumen/Watt High Power** 2480lm/30,3W per m

Lumen Values: Luminaire luminous flux at 4000K/CRI>80. Other configurations on request.



**W** Snow White

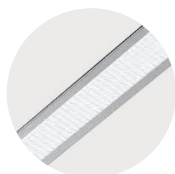

**S** Radiant Silver



**U** Urban Graphite



**B** Jet Black



**H** Anodic Champagne



**K** Satin Copper