

Downlights with trim

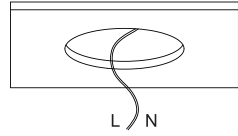

1 - Cut out the hole in the ceiling (see table for cutout size)
Find the power cable to connect the lamp

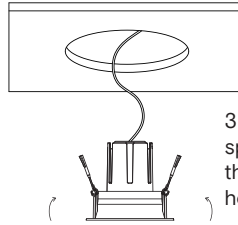

3 - Hold back the spring clips then push the downlight into the hole

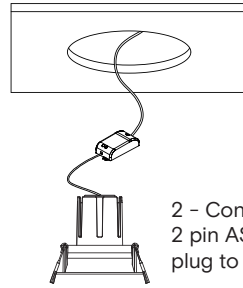

2 - Connect the 2 pin AS/NZS plug to power

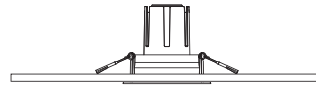

4 - Make sure the downlight is fixed tightly in the ceiling.
Turn on power

Model SKU	Diameter (mm)	Cutout (mm)	IP rating
G2-TR12TA	71	76	20
G2-TR12T	71	76	20
G2-TR12RA	85	75	20
G2-TR12R	85	75	20
G2-TR12SA	85x85	75	20
G2-TR12RA2	104	95	20
G2-TR12RA3	108	95	20
G2-TR24RA	115	100	20
G2-TR24R	115	100	20
G2-TR24SA	112x112	100	20
G2-TR24RA2	125	110	20
G2-TR24RA3	125	110	20
G2-TR33RA	140	125	20
G2-TR33R	140	125	20
G2-TR33SA	140x140	125	20
G2-TR33RA2	145	130	20
G2-TR33RA3	145	130	20

grace

THRIVE Reflector Installation Manual



Safety Instructions

1. Turn off power before installation or before doing any maintenance work.
2. Do not install any luminaire near a heat source.
3. For Indoor use.
4. Do not exceed the nominal supply voltage or amperage ratings.
5. All wiring and installation of this luminaire must adhere to local and national wiring rules eg AS/NZS 3000:2007 Amendment 2:2012 Electrical Installation
6. Take care not to pull any electrical wires during unpacking as this may damage the connection.
7. Lay out all the components on a smooth surface and make sure there are no components missing before assembling.
8. To avoid injury or damage to the fitting, please ensure that power leads and screws are secure before connecting the power.
9. Please keep instructions for future reference.

IC-F Installation Instruction (Downlights under 13W)

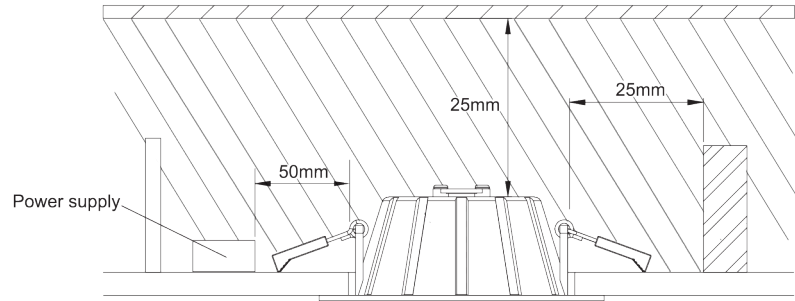

Rear of fitting may abut structural members and building elements. Do not install through or directly into joist, beam, rafter or ceiling batten.

Side Clearance from heatsink to building element (e.g. timber, joist or batten) - SCB	0 mm
Height Clearance from heatsink to building element (e.g. timber, joist or batten) - HCB	0 mm
Minimum insulation clearance to building element - MIC	0 mm



Recessed luminaires and their associated equipment may pose a risk of fire or damage to property if not installed and maintained correctly. Novii recommends a clearance of 25mm to building elements for optimum lifespan.

This data sheet contains information necessary to ensure compliance with the New Zealand Electrical Code of Practice for Installation and Maintenance of Recessed Luminaires and Associated Equipment AS/NZS 60598.2.2:2001

Note : Above 13W, Downlights are Non-IC

Installation Procedure

WARNING

1. Switch off before installation.
2. Switch on only after complete installation and examination of the circuit.
3. Professional electrician for installation and maintenance only.



Turn Off power supply before starting any installation. Read instructions & check you have all the tools & accessories to complete the installation correctly.

Trimless Downlights

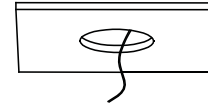

- 1 - Switch the power off at first
Cut out a hole in the ceiling (see table)
Find the power cable to connect the fixture

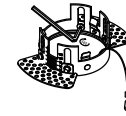

- 2 - Adjust the height required by the borderless frame

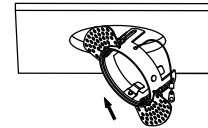

- 3 - Put the frame into the ceiling so that the stencil fits the ceiling

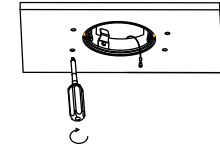

- 4 - Use screws at both ends of the stencil

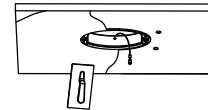

- 5 - Fill the screw hole with plaster and make good

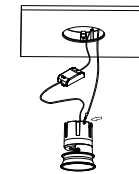

- 6 - Connect the driver to the fixture and fasten the safety rope

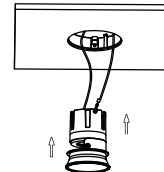

- 7 - Insert the fixture body into the frame

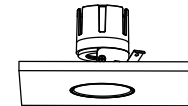

- 8 - The installation is complete