

grace

SILHOUETTE Void Installation Manual

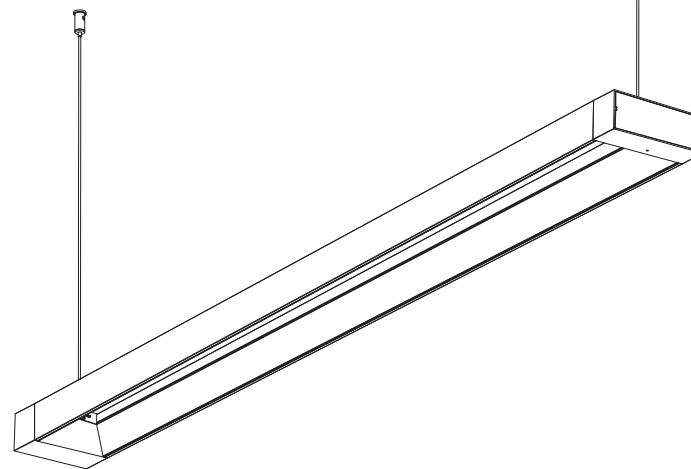

Safety Instructions

1. Turn off power before installation or before doing any maintenance work.
 2. Do not install any luminaire near a heat source.
 3. For Indoor use.
 4. Do not exceed the nominal supply voltage or amperage ratings.
 5. All wiring and installation of this luminaire must adhere to local and national wiring rules eg AS/NZS 3000:2007 Amendment 2:2012
- Electrical Installation
6. Take care not to pull any electrical wires during unpacking as this may damage the connection.
 7. Lay out all the components on a smooth surface and make sure there are no components missing before assembling.
 8. To avoid injury or damage to the fitting, please ensure that power leads and screws are secure before connecting the power.
 9. Please keep instructions for future reference.

Installation Procedure

WARNING

1. Switch off before installation.
2. Switch on only after complete installation and examination of the circuit.
3. Professional electrician for installation and maintenance only.

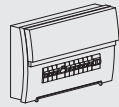

Turn Off
Power Supply

Turn Off power supply before starting any installation. Read instructions & check you have all the tools & accessories to complete the installation correctly.

Installation (Built-out)

STEP 1

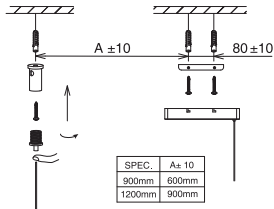

Fix the holders of suspending ropes and surface mounted frame on the ceiling.

STEP 2

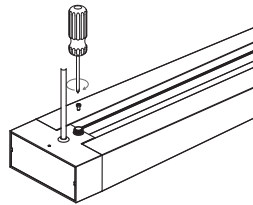

Fix the pedestal of suspending ropes on the lamp by screws.

STEP 3

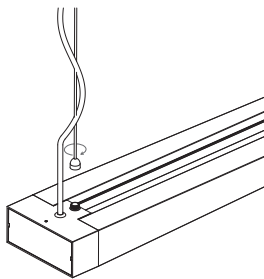

Fix the suspending wires on the base.

STEP 4

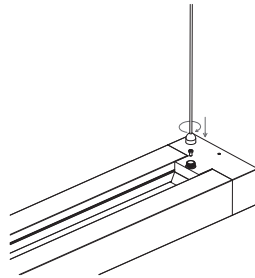

Take down the 1pcs flat-head screws on the back of lamp, fix the suspending accessories on the lamp.

STEP 5

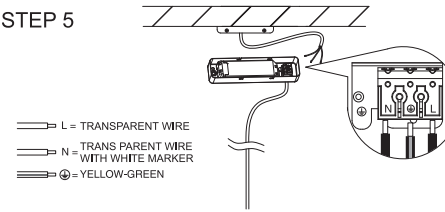

Connect wire mains cable into quick terminal block.

STEP 6

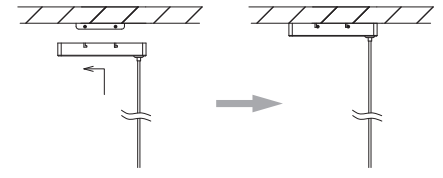

Put the surface mounted frame into the screw slot of installation fixture. Fix the screws, settle the input wires properly and switch on.

Installation (Built-in)

STEP 1

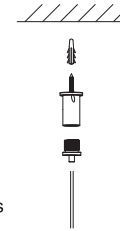

Fix the holders of suspending ropes on the ceiling.

STEP 2

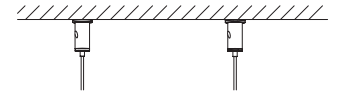

Keep the proper distances of the 2pcs suspending ropes as below table.

SPEC.	A ± 10
900mm	810mm
1200mm	1110mm
1600mm	1510mm

STEP 3

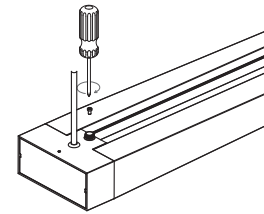

Fix the pedestal of suspending ropes on the lamp by screws.

STEP 4

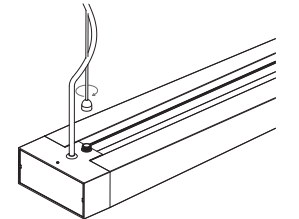

Fix the suspending wires on the base.

STEP 5

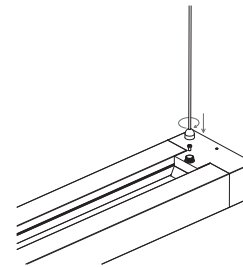

Take down the 1pcs flat-head screws on the back of lamp, fix the suspending accessories on the lamp.

STEP 6

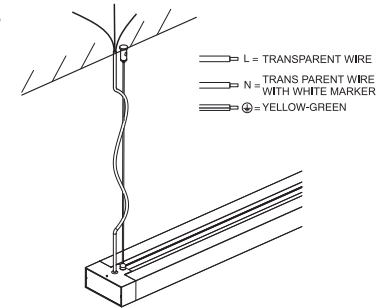

Settle the input wires properly and switch on.