

Important Safety Instructions:

1. Turn off power before installation or before doing any maintenance work.
2. Do not install any luminaire near a heat source.
3. For Outdoor and Indoor use.
4. Do not exceed the nominal supply voltage or amperage ratings.
5. All wiring and installation of this luminaire must adhere to local and national wiring rules eg AS/NZS 3000:2007 Amendment 2:2012 Electrical Installation
6. Take care not to pull any electrical wires during unpacking as this may damage the connection.
7. Lay out all the components on a smooth surface and make sure there are no components missing before assembling.
8. To avoid injury or damage to the fitting, please ensure that power leads and screws are secure before connecting the power.
9. Please keep instructions for future reference.

Installation Procedure

WARNING ⚡

1. Switch off before installation.
2. Switch on only after complete installation and examination of the circuit.
3. Professional electrician for installation and maintenance only.

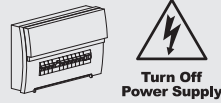

Turn Off power supply before starting any installation. Read instructions & check you have all the tools & accessories to complete the installation correctly.

Installation

Step 1

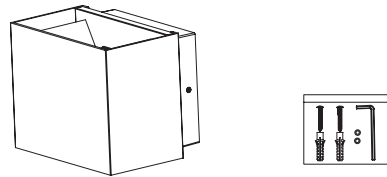

Take out the lamp and accessories.

Step 2

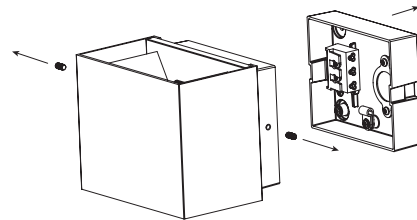

Take out the base from the lamp body.

Step 3

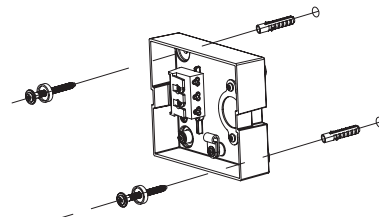

Fix the base on the wall and make the wires through the hole of the base.

Step 4

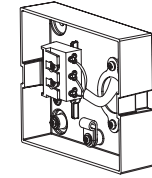
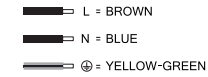

Set the wires respectively.

Step 5

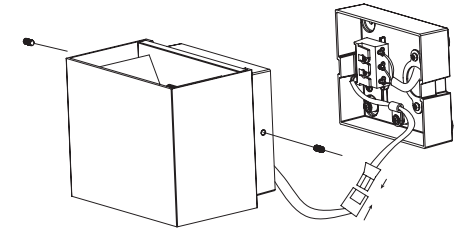

Get the lamp fixture back to the base and fix it well.

Step 6

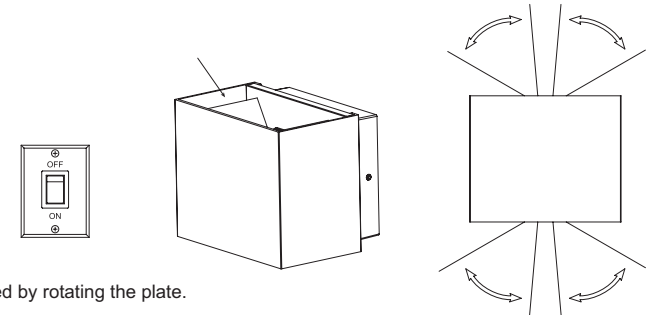

The beam angle can be adjusted by rotating the plate.

Base plate, cable entry gland and screw heads must be covered in silicon sealant. Failure to do so will cause luminaire failure from water ingress