

TYKE

CREATIVE

The Tyke Linear Range of luminaires has been developed on the basic principles of creativity and playfulness. Modular connections allow for unique configurations that are limited only by your imagination. Tyke delivers customised, high performing and human centric lighting solutions across every environment.

TYKE
/ creative light /

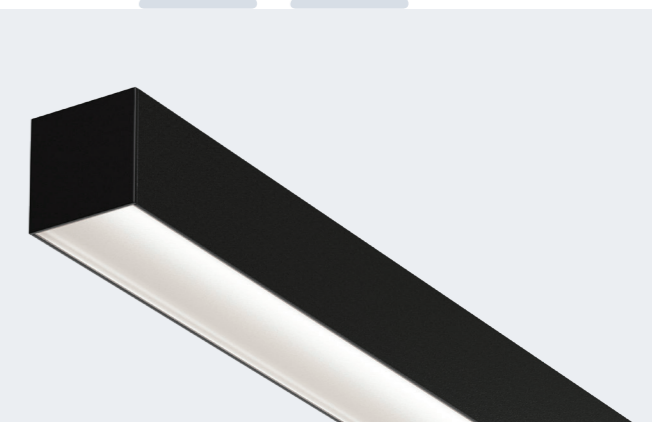
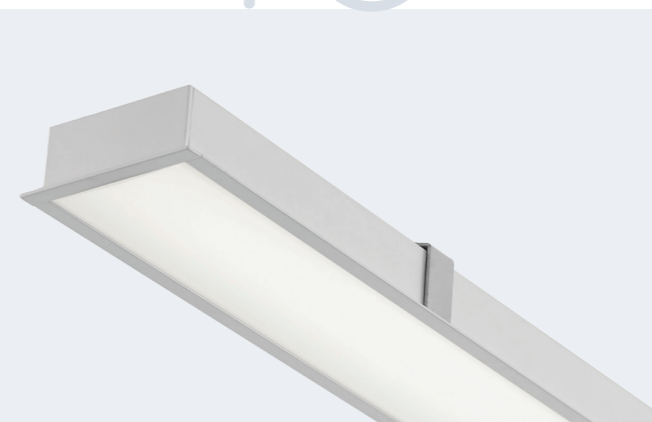
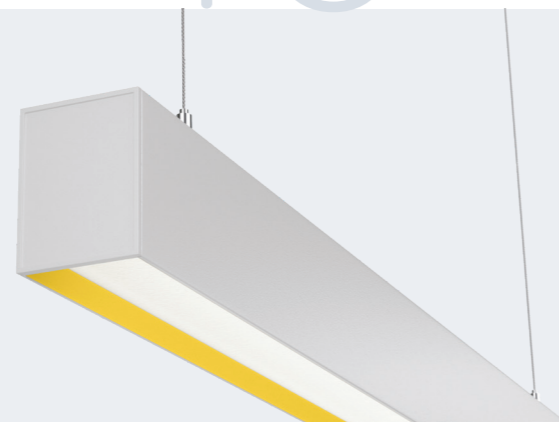
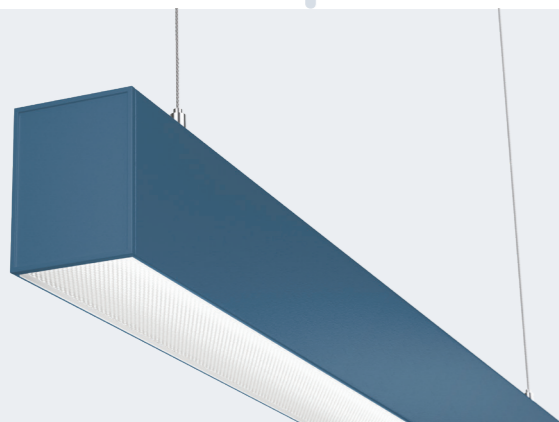

RIDGE

series

The Ridge is a streamlined, elegant connectable linear system with modular configurations that deliver limitless design possibilities.

DIMENSIONS

78mmW x 102mmH

INSET MODULES



Prismatic



Opal



Baffle

NIXON

series

The Nixon is a fully connectable linear system with sleek modern proportions. Completely customisable this series delivers creative solutions across all environments.

DIMENSIONS

62mmW x 82mmH

INSET MODULES



Prismatic



Opal



Baffle

HARLEY

series

The Harley Series offers sophisticated recessed linear profile with direct light distribution. A range of dimensions are designed to enhance retail and commercial spaces.

DIMENSIONS

56 56mmW x 32mmH

75 75mmW x 37mmH

90 90mmW x 42mmH

CUSTOM

series

The Custom Series delivers infinite design solutions with a range of profiles and LED ribbon tailored for a wide variety of environments.

DIMENSIONS

TC13 16mmW x 10mmH

TC16 17.1mmW x 15mmH

TC24 35.2mmW x 34.9mmH

TC35 35mmW x 35mmH



**RIDGE**
series

The Ridge is a streamlined, elegant connectable linear system with slim proportions. A 78x102 dimension with opal, prismatic and baffle optics produces a variety of design possibilities. The Ridge can be surface mounted or suspended in a range of colours and connections to create stunning office and commercial environments.



RIDGE series

START...>

1

CHOOSE YOUR INSET

The Ridge Series offers a range of modular optics designed to deliver human centric lighting outputs.

Prismatic

A pattern of prism-like shapes easily disperses light and provides excellent glare reduction properties (UGR < 19).

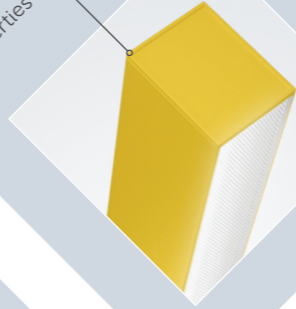

Baffle

The Baffle optic delivers excellent glare control and a clean line of light diffusion.

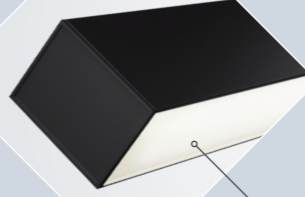

Opal

Opal optics provide a clean looking aesthetic and extremely efficient diffusion of light.

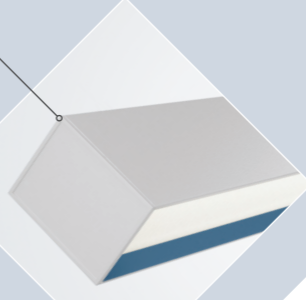

CHOOSE YOUR CONFIGURATION

Direct/Indirect

Depending on what you choose to feature, the Ridge Series is versatile and has both up and down directional light.



3

Connect

The Ridge Series has a number of modular connection options giving you the freedom to create free-flowing shapes and lines.

Straight

L-Connect

T-Connect

Cross-Connect

2 PICK YOUR COLOUR

*Dulux Colours of New Zealand®



White

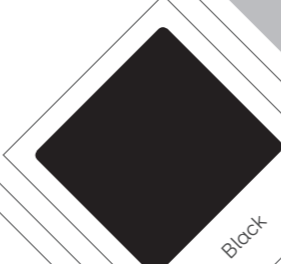

Black

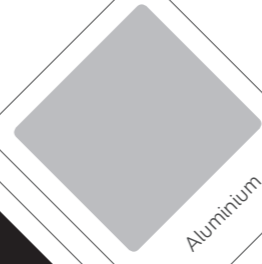

Aluminium



Lawrence*

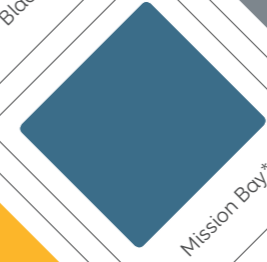

Mission Bay*

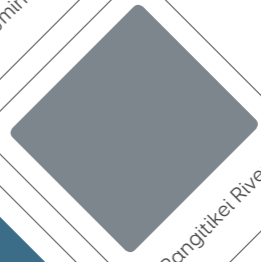

Rangitikei River*

A broad range of colour options will breathe life into any environment without limiting your creativity. Outside of our standard options we can provide custom colours on request.

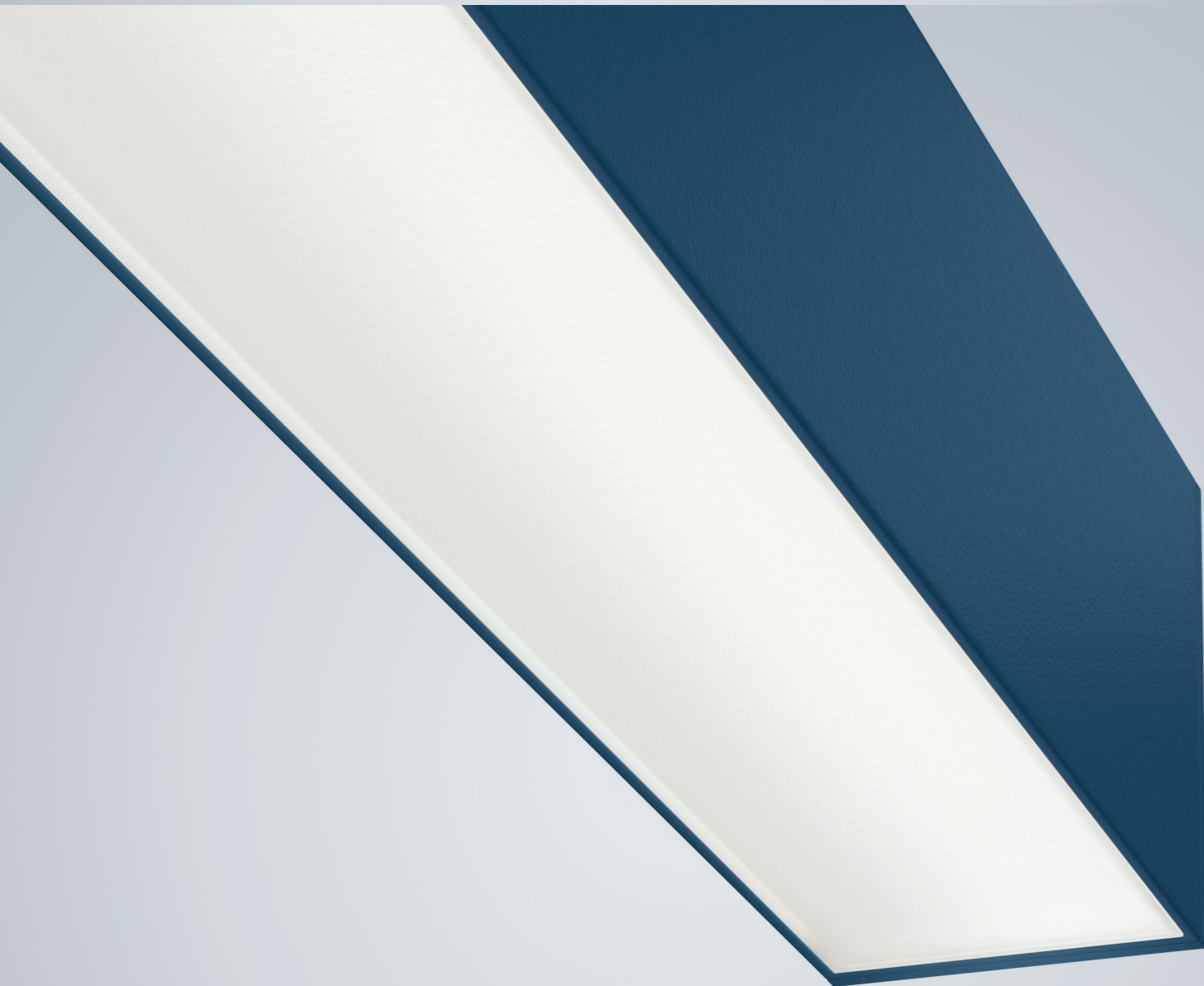
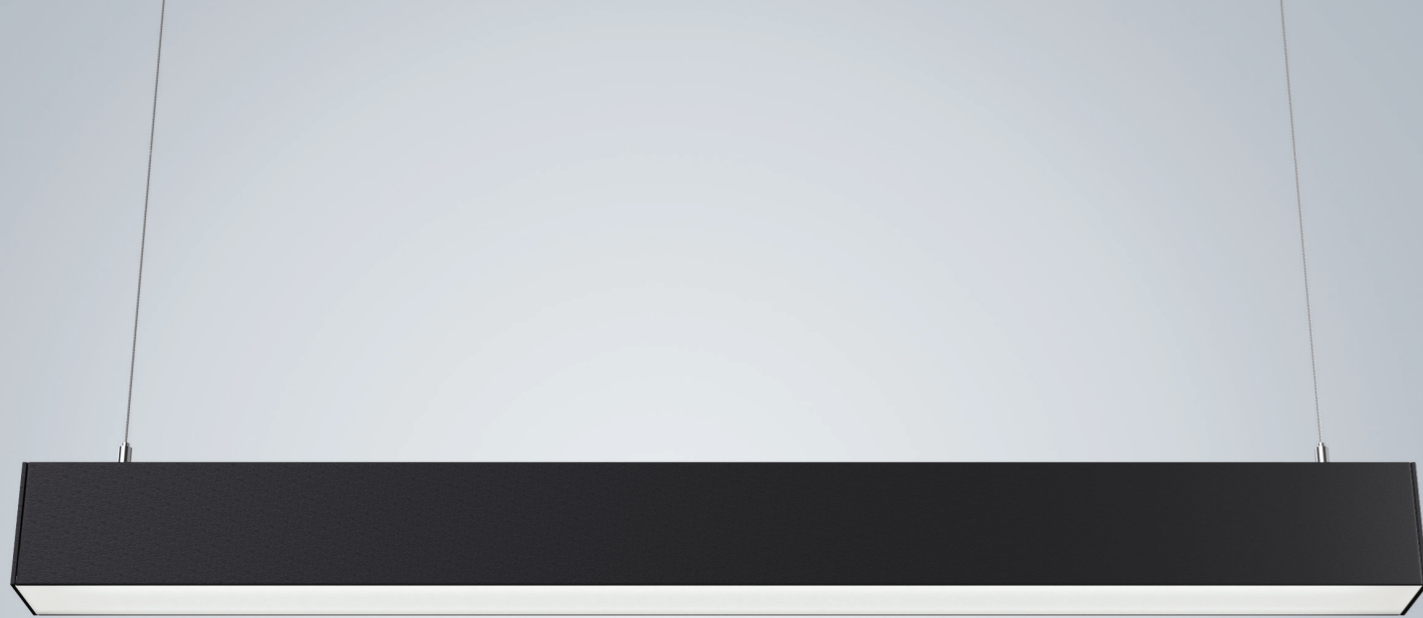









RIDGE SERIES

TECHNICAL FEATURES

Light Source Samsung LED
Luminaire Efficacy 80-90 lm/W
Chromaticity Tolerance (initial MacAdam) 3
Rated Median Useful Life* 50000h L70 at 25°C
Ballast 1x Lifud (5 Year Warranty)
Maintenance Category D - Enclosed IP2X

CUSTOM FEATURES

Optics Opal/Prismatic/Baffle
Light Distribution Direct and Direct-Indirect
Mounting Options Suspended/Surface Mount
Colour Rendering Index min. 80
Correlated Colour Temperature* 2700-6000k
Dimming 0-10v, DALI
Linkable Power and Mechanically Linkable
Colours White, Black, Aluminium, Lawrence, Mission Bay, Rangitikei River, Custom

| | | | |
|---|------------------|---|---------------------|
|  | Suspension Mount |  | Straight Connection |
|  | Surface Mount |  | L Connect |
|  | Ceiling Rose |  | T Connect |
|  | End Cap |  | Cross Connect |



DIRECT ILLUMINATION

| Width/Height | Length | Power |
|--------------|---------------|-------|
| 78x102 | 573mm | 15 |
| 78x102 | 853mm | 22 |
| 78x102 | 1133mm | 30 |
| 78x102 | 1413mm | 38 |
| 78x102 | 1693mm | 45 |
| 78x102 | 1793mm | 52 |
| 78x102 | 2253mm | 60 |
| 78x102 | L Connect | 15 |
| 78x102 | T Connect | 15 |
| 78x102 | Cross Connect | 15 |

DIRECT/INDIRECT ILLUMINATION

| Width/Height | Length | Power |
|--------------|---------------|-------|
| 78x102 | 573mm | 22.5 |
| 78x102 | 853mm | 33 |
| 78x102 | 1133mm | 45 |
| 78x102 | 1413mm | 57 |
| 78x102 | 1693mm | 67.5 |
| 78x102 | 1793mm | 78 |
| 78x102 | 2253mm | 90 |
| 78x102 | L Connect | 22.5 |
| 78x102 | T Connect | 22.5 |
| 78x102 | Cross Connect | 22.5 |



NIXON

series

The Nixon is a fully connectable linear system with sleek modern proportions. Available in both direct and indirect options with a 62x82mm dimension. Completely customisable in colour and through multiple connection options this system delivers endless creative possibilities.



MIXXON series

START ...

1

CHOOSE YOUR INSET

The Nixon Series offers a range of modular optics designed to deliver human centric lighting outputs.

Prismatic

A pattern of prism-like shapes easily disperses light and provides excellent glare reduction properties (UGR < 19).



Opal

Opal optics provide a clean looking aesthetic and extremely efficient diffusion of light.

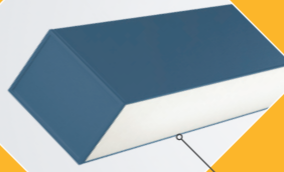

Baffle

The Baffle optic delivers excellent glare control and a clean line of light diffusion.

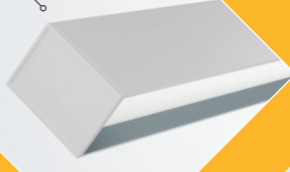

3

CHOOSE YOUR CONFIGURATION

Direct/Indirect

Depending on what you choose to feature, the Nixon Series is versatile and has both up and down directional light.



Connect

The Nixon Series has a number of modular connection options giving you the freedom to create free-flowing shapes and lines.

- Straight
- L-Connect
- T-Connect
- Cross-Connect

2 PICK YOUR COLOUR

*Dulux Colours of New Zealand®



A broad range of colour options will breathe life into any environment without limiting your creativity. Outside of our standard options we can provide custom colours on request.

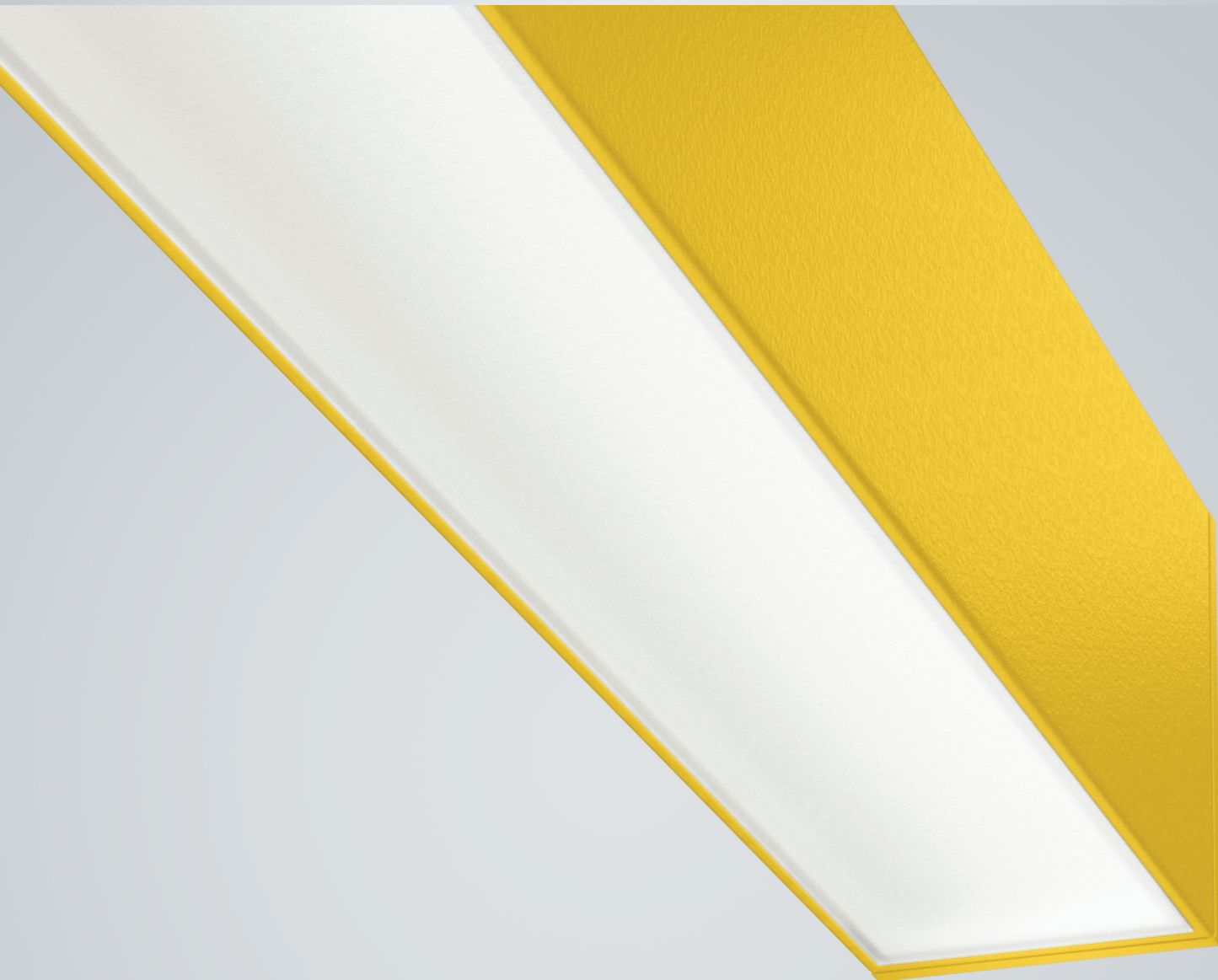
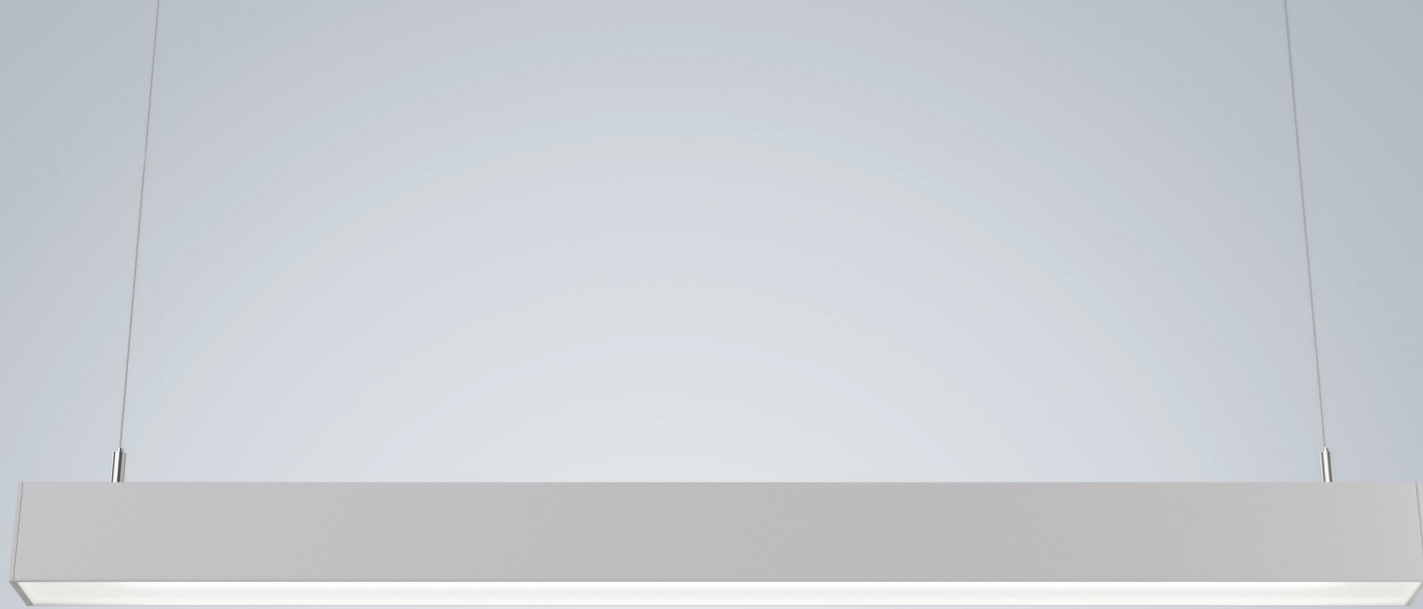









NIXON SERIES

TECHNICAL FEATURES

Light Source Samsung LED
Luminaire Efficacy 80-90 lm/W
Chromaticity Tolerance (initial MacAdam) 3
Rated Median Useful Life* 50000h L70 at 25°C
Ballast 1x Lifud (5 Year Warranty)
Maintenance Category D - Enclosed IP2X

CUSTOM FEATURES

Optics Opal/Prismatic/Baffle
Light Distribution Direct and Direct-Indirect
Mounting Options Suspended/Surface Mount
Colour Rendering Index min. 80
Correlated Colour Temperature* 2700-6000k
Dimming 0-10v,DALI
Linkable Power and Mechanically Linkable
Colours White, Black, Aluminium, Lawrence, Mission Bay, Rangitikei River, Custom

| | | | |
|---|------------------|---|---------------------|
|  | Suspension Mount |  | Straight Connection |
|  | Surface Mount |  | L Connect |
|  | Ceiling Rose |  | T Connect |
|  | End Cap |  | Cross Connect |



DIRECT ILLUMINATION

| Width/Height | Length | Power |
|--------------|---------------|-------|
| 62x82 | 573mm | 15 |
| 62x82 | 853mm | 22 |
| 62x82 | 1133mm | 30 |
| 62x82 | 1413mm | 38 |
| 62x82 | 1693mm | 45 |
| 62x82 | 1793mm | 52 |
| 62x82 | 2253mm | 60 |
| 62x82 | L Connect | 15 |
| 62x82 | T Connect | 15 |
| 62x82 | Cross Connect | 15 |

DIRECT/INDIRECT ILLUMINATION

| Width/Height | Length | Power |
|--------------|---------------|-------|
| 62x82 | 573mm | 22.5 |
| 62x82 | 853mm | 33 |
| 62x82 | 1133mm | 45 |
| 62x82 | 1413mm | 57 |
| 62x82 | 1693mm | 67.5 |
| 62x82 | 1793mm | 78 |
| 62x82 | 2253mm | 90 |
| 62x82 | L Connect | 22.5 |
| 62x82 | T Connect | 22.5 |
| 62x82 | Cross Connect | 22.5 |



HARLEY

series

The Harley is a sophisticated recessed linear profile with direct light distribution. A range of dimensions are designed to enhance retail and commercial spaces. Its applications are diverse - in ceilings, washing down walls or wall mounted.



HARLEY 56

TECHNICAL FEATURES

Light Source Samsung LED
Luminaire Efficacy 80-90 lm/W
Colour Rendering Index min. 80
Chromaticity Tolerance (initial MacAdam) 3
Rated Median Useful Life* 50000h L70 at 25°C
Ballast 1x Lifud (5 Year Warranty)
Maintenance Category D - Enclosed IP2X

CUSTOM FEATURES

Optics Opal
Light Distribution Direct
Mounting Options Recessed
Correlated Colour Temperature* 2700-6000k
Dimming 0-10v, DALI
Linkable Power and Mechanically Linkable
Colours White, Black, Anodised Aluminium, Custom



DIRECT ILLUMINATION

| Width/Height | Length | Power |
|--------------|--------|-------|
| 56x32 | 868mm | 22 |
| 56x32 | 1148mm | 30 |
| 56x32 | 1428mm | 38 |
| 56x32 | 1708mm | 45 |
| 56x32 | 1988mm | 52 |
| 56x32 | 2268mm | 60 |

HARLEY 75

TECHNICAL FEATURES

Light Source Samsung LED
Luminaire Efficacy 80-90 lm/W
Colour Rendering Index min. 80
Chromaticity Tolerance (initial MacAdam) 3
Rated Median Useful Life* 50000h L70 at 25°C
Ballast 1x Lifud (5 Year Warranty)
Maintenance Category D - Enclosed IP2X

CUSTOM FEATURES

Optics Opal
Light Distribution Direct
Mounting Options Recessed
Correlated Colour Temperature* 2700-6000k
Dimming 0-10v, DALI
Colours White, Black, Anodised Aluminium, Custom



DIRECT ILLUMINATION

| Width/Height | Length | Power |
|--------------|--------|-------|
| 75x37 | 882mm | 22 |
| 75x37 | 1162mm | 30 |
| 75x37 | 1442mm | 38 |
| 75x37 | 1722mm | 45 |
| 75x37 | 2002mm | 52 |
| 75x37 | 2282mm | 60 |

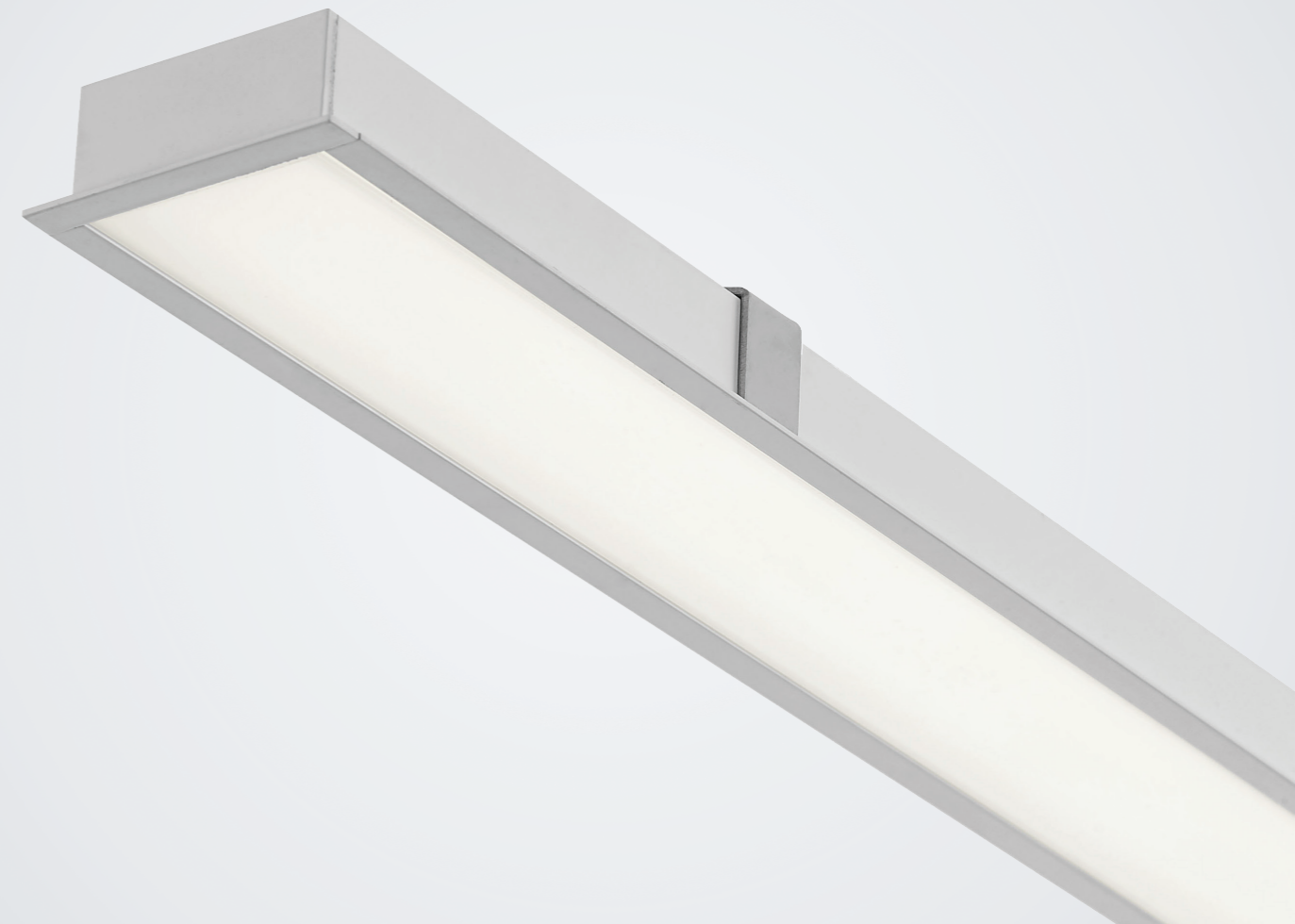

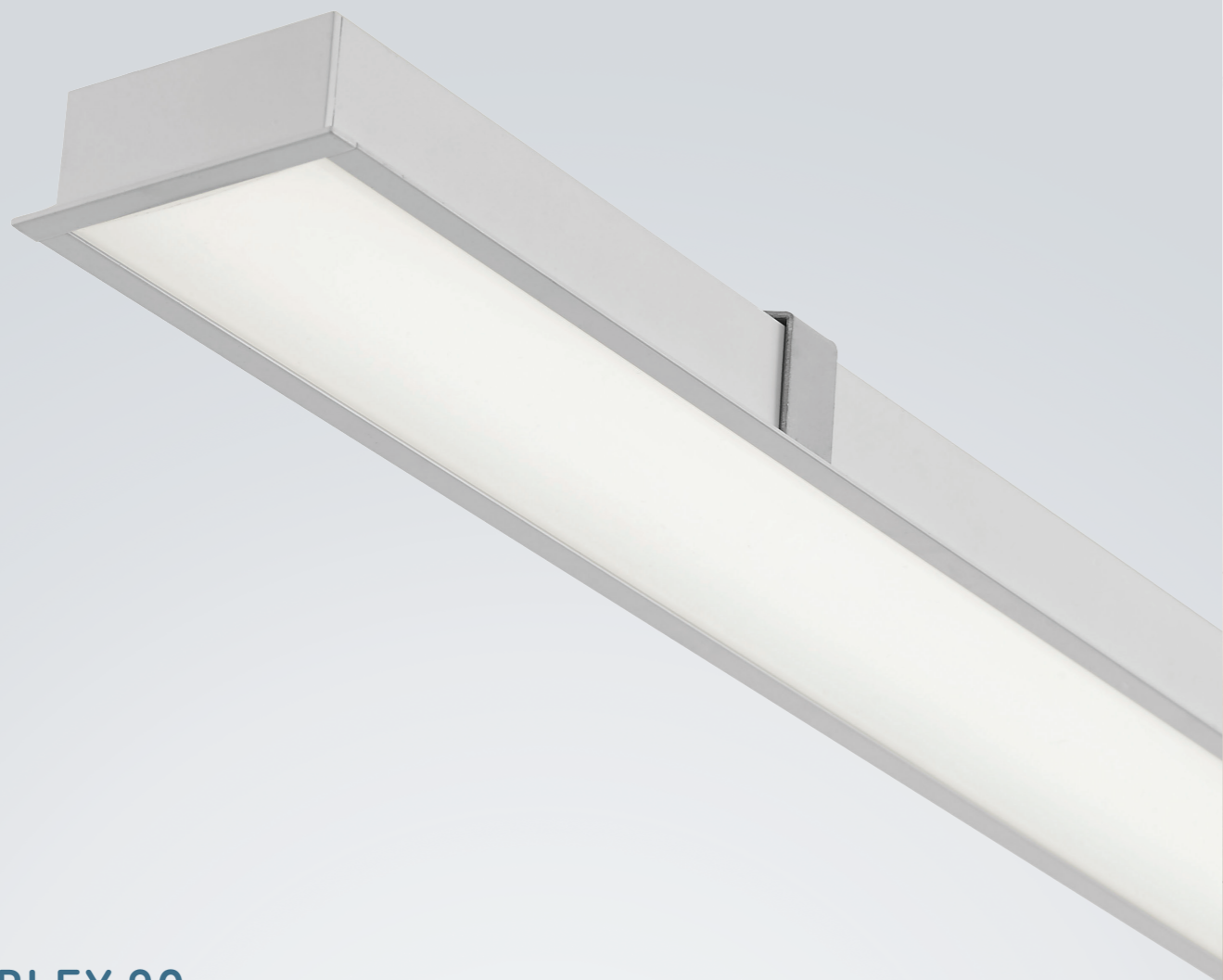

HARLEY 90

TECHNICAL FEATURES

Light Source Samsung LED
Luminaire Efficacy 80-90 lm/W
Colour Rendering Index min. 80
Chromaticity Tolerance (initial MacAdam) 3
Rated Median Useful Life* 50000h L70 at 25°C
Ballast 1x Lifud (5 Year Warranty)
Maintenance Category D - Enclosed IP2X

CUSTOM FEATURES

Optics Opal
Light Distribution Direct
Mounting Options Recessed
Correlated Colour Temperature* 2700-6000k
Dimming 0-10v, DALI
Colours White, Black, Anodised Aluminium, Custom

DIRECT ILLUMINATION

| Width/Height | Length | Power |
|--------------|--------|-------|
| 90x42 | 882mm | 22 |
| 90x42 | 1162mm | 30 |
| 90x42 | 1442mm | 38 |
| 90x42 | 1722mm | 45 |
| 90x42 | 2002mm | 52 |
| 90x42 | 2282mm | 60 |





CUSTOM
series

The Custom Series delivers infinite design solutions with a range of profiles and LED ribbon tailored for a wide variety of environments.

CUSTOM TC13

TC13 provides direct illumination in customisable lengths. Continuous lines can be recessed or surface mounted. Dimming options are available.

TECHNICAL FEATURES

Optics Opal
Light Distribution Direct
Light Source Samsung LED
Luminaire Efficacy 80-90 lm/W
Colour Rendering Index min. 80
Chromaticity Tolerance (initial MacAdam) 3
Rated Median Useful Life* 50000h L70 at 25°C
Ballast Meanwell (5 Year Warranty)

CUSTOM FEATURES

Cutting Every 50mm
Structure Flexible
Power 9.6W/m-17W/m
Correlated Colour Temperature* 2700-6000k/RGB/RGBW
Dimming 0-10v/DMX512/DALI
Maintenance Category IP20/IP65
Colours White, Black, Anodised Aluminium, Custom

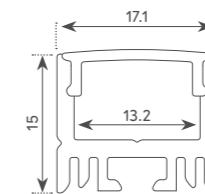
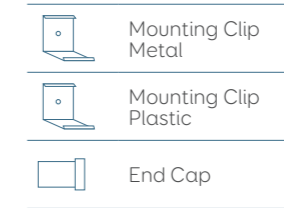

CUSTOM TC16

TC16 offers a clean and minimal aesthetic perfect for washing walls and objects with light 45 degrees from the surface. Continuous lines can be controlled with multiple dimming systems.

TECHNICAL FEATURES

Optics Opal
Light Distribution Direct
Light Source Samsung LED
Luminaire Efficacy 80-90 lm/W
Chromaticity Tolerance (initial MacAdam) 3
Rated Median Useful Life* 50000h L70 at 25°C
Ballast Meanwell (5 Year Warranty)

CUSTOM FEATURES

Cutting Every 50mm
Structure Flexible
Power 9.6W/m-17W/m
Correlated Colour Temperature* 2700-6000k/RGB/RGBW
Dimming 0-10v/DMX512/DALI
Maintenance Category IP20/IP65
Colours White, Black, Anodised Aluminium, Custom

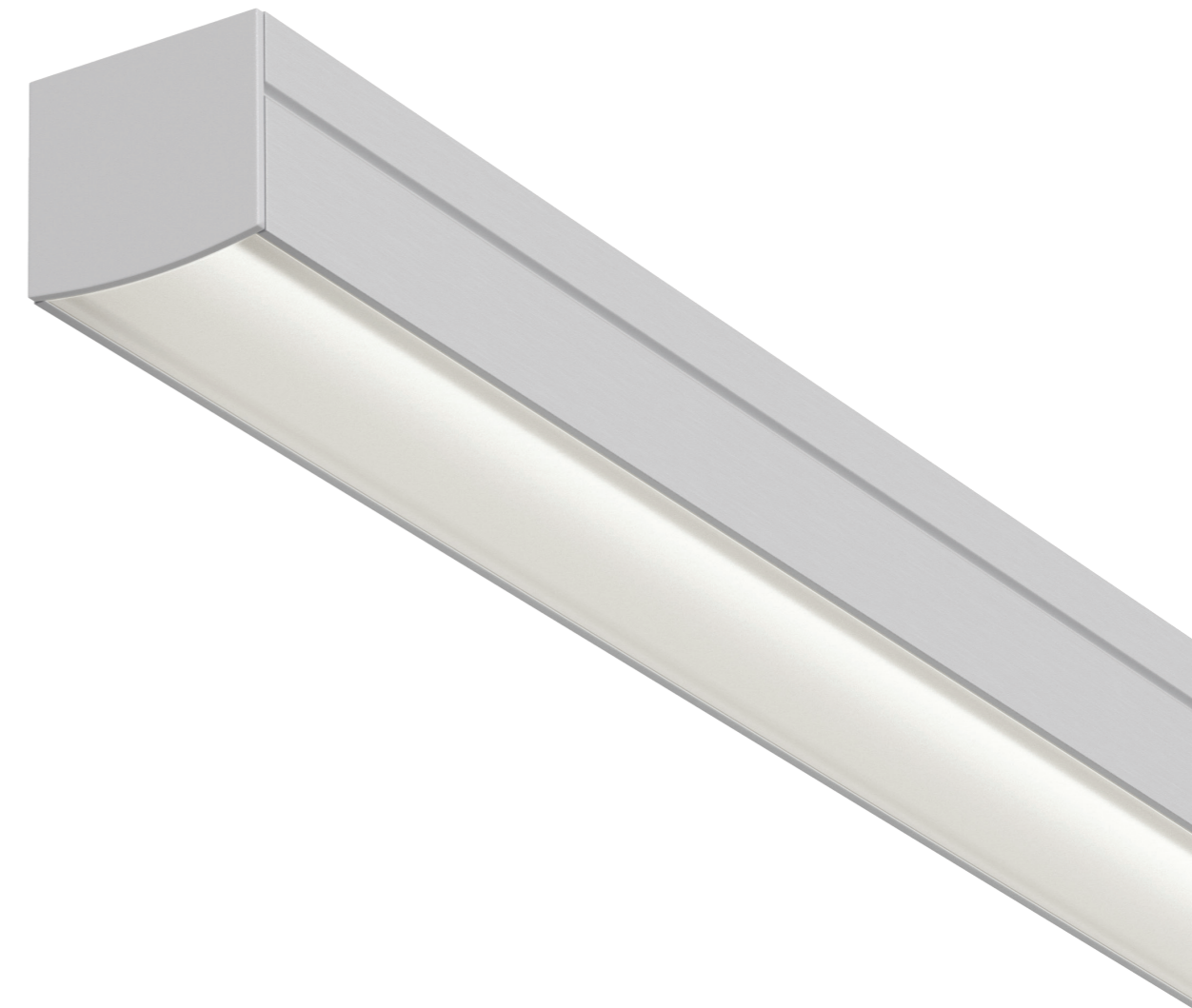
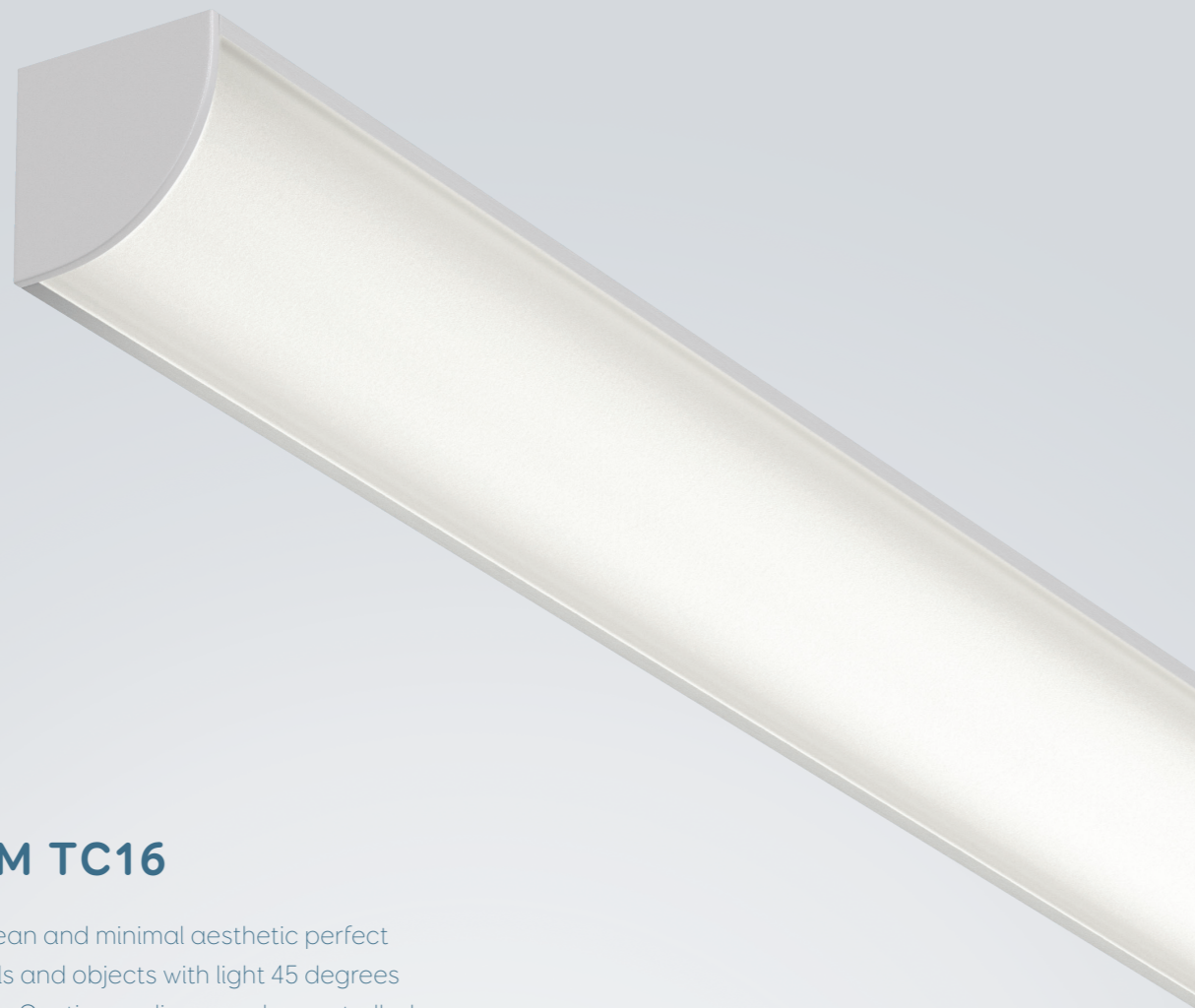
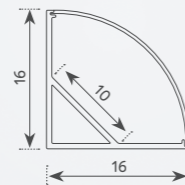
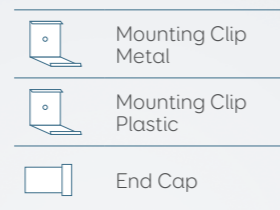

CUSTOM TC24

TC24 delivers clean recessed lines of continuous light for walls and ceilings. Connection options allow for seamless light lines through 90 degree angles. Power density up to 34W/m.

TECHNICAL FEATURES

Optics Opal
Light Distribution Direct
Light Source Samsung LED
Mechanically linkable for continuous runs
Recessed via spring loaded clips
Luminaire Efficacy 80-90 lm/W
Colour Rendering Index min. 80
Chromaticity Tolerance (initial MacAdam) 3
Rated Median Useful Life* 50000h L70 at 25°C
Ballast Meanwell (5 Year Warranty)

CUSTOM FEATURES

Cutting Every 50mm
Recessed Corner Joints for continuous in wall/ceiling applications
Structure Flexible
Power 9.6W/m-17W/m
Correlated Colour Temperature* 2700-6000k/RGB/RGBW
Dimming 0-10v/DMX512/DALI
Maintenance Category IP20/IP65
Colours White, Black, Anodised Aluminium, Custom

| | |
|---|-----------------------|
|  | Mounting Clip Metal |
|  | Mounting Clip Plastic |
|  | End Cap |
|  | Straight Connection |
|  | Recessed Clip |

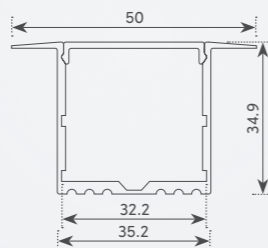

CUSTOM TC35





TC35 is a versatile linear profile that can surface mounted or suspended to create multiple shapes and endless lines of light.

TECHNICAL FEATURES

Optics Opal
Light Distribution Direct
Light Source Samsung LED
Mechanically linkable for continuous runs
Luminaire Efficacy 80-90 lm/W
Colour Rendering Index min. 80
Chromaticity Tolerance (initial MacAdam) 3
Rated Median Useful Life* 50000h L70 at 25°C
Ballast Meanwell (5 Year Warranty)

CUSTOM FEATURES

Cutting Every 50mm
Mounting Surface/Suspended
Corner Joints for continuous wall/ceiling applications
Structure Flexible
Power 9.6W/m-17W/m
Correlated Colour Temperature* 2700-6000k/RGB/RGBW
Dimming 0-10v/DMX512/DALI
Maintenance Category IP20/IP65
Colours White, Black, Anodised Aluminium, Custom

| | |
|---|-----------------------|
|  | Mounting Clip Metal |
|  | Mounting Clip Plastic |
|  | End Cap |
|  | Suspension Mount |
|  | Ceiling Rose |

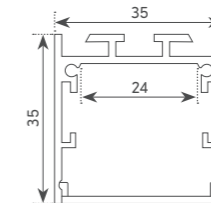

/ creative light /
TYKE

NOVII

17B Pollen St, Grey Lynn, Auckland 1021, New Zealand
info@novii.co.nz | 0800 663 353 | novii.co.nz